



**GCU08BA-130**

**HIGH POWER INVERTER USE  
PRESS PACK TYPE**

**GCT PART**

**MAXIMUM RATINGS**

Symbol	Parameter	Conditions	Voltage class	Unit
VRRM	Repetitive peak reverse voltage	—	6500	V
VRSM	Non-repetitive peak reverse voltage	—	6500	V
VDRM	Repetitive peak off-state voltage	Gate driver energized	6500	V
VDSM	Non-repetitive peak off-state voltage	Gate driver energized	6500	V
V(LTDS)	Long term DC stability voltage	Gate driver energized, $\lambda = 100$ Fit	3600	V

Symbol	Parameter	Conditions	Ratings	Unit
IT(RMS)	RMS on-state current	Applied for all condition angles	520	A
IT(AV)	Average on-state current	$f = 60\text{Hz}$ , sinewave $\theta = 180^\circ$ , $T_f = 62^\circ\text{C}$	330	A
ITQRM	Repetitive controllable on-state current	$V_{DM} = 3/4 V_{DRM}$ , $V_D = 3000\text{V}$ , $L_C = 0.3\mu\text{H}$ $T_j = 25/125^\circ\text{C}$ (See Fig. 1, 3)	800	A
ITSM	Surge on-state current	One half cycle at 60Hz, $T_j = 125^\circ\text{C}$ start	4.8	kA
$\int I^2 dt$	Current-squared, time integration		$9.6 \times 10^4$	A <sup>2</sup> s
diT/dt	Critical rate of rise of on-state current	$V_D = 3000\text{V}$ , $I_T = 800\text{A}$ , $C_s = 0.1\mu\text{F}$ , $R_s = 10\Omega$ $T_j = 25/125^\circ\text{C}$ , $f = 60\text{Hz}$ (See Fig. 1, 2)	1000	A/ $\mu\text{s}$
diR/dt	Critical rate of rise of reverse recovery current	$I_T = 800\text{A}$ , $V_R = 3000\text{V}$ , $T_j = 25/125^\circ\text{C}$ $C_s = 0.1\mu\text{F}$ , $R_s = 10\Omega$ (See Fig. 4, 5)	1000	A/ $\mu\text{s}$
PFGM	Peak forward gate power dissipation		5	kW
PRGM	Peak reverse gate power dissipation		17	kW
PFG(AV)	Average forward gate power dissipation		100	W
PRG(AV)	Average reverse gate power dissipation		120	W
VFGM	Peak forward gate voltage		10	V
VRGM	Peak reverse gate voltage		21	V
IFGM	Peak forward gate current		500	A
IRGM	Peak reverse gate current		800	A

**ELECTRICAL CHARACTERISTICS**

Symbol	Parameter	Conditions	Limits			Unit
			Min	Typ	Max	
V <sub>TM</sub>	On-state voltage	$I_T = 400\text{A}$ , $T_j = 125^\circ\text{C}$	—	—	5.5	V
I <sub>RRM</sub>	Repetitive peak reverse current	$V_{RM} = 6500\text{V}$ , $T_j = 125^\circ\text{C}$	—	—	250	mA
I <sub>DRM</sub>	Repetitive peak off-state current	$V_{DM} = 6500\text{V}$ , $T_j = 125^\circ\text{C}$ , Gata driver energized	—	—	100	mA
I <sub>G</sub> RM	Reverse gate current	$V_{RG} = 21\text{V}$ , $T_j = 125^\circ\text{C}$	—	—	40	mA
dv/dt	Critical rate of rise of off-state voltage	$V_D = 3000\text{V}$ , $T_j = 125^\circ\text{C}$ Gate driver energized (Expo. wave)	3000	—	—	V/ $\mu\text{s}$
t <sub>gt</sub>	Turn-on time	$I_T = 800\text{A}$ , $V_D = 3000\text{V}$ , $di/dt = 1000\text{A}/\mu\text{s}$ , $T_j = 125^\circ\text{C}$	—	—	5	$\mu\text{s}$
t <sub>d</sub>	Turn-on delay time	$C_s = 0.1\mu\text{F}$ , $R_s = 10\Omega$ (See Fig. 1, 2)	—	—	1	$\mu\text{s}$
E <sub>on</sub>	Turn-on switching energy	$I_T = 400\text{A}$ , $V_D = 3000\text{V}$ , $di/dt = 1000\text{A}/\mu\text{s}$ $C_s = 0.1\mu\text{F}$ , $R_s = 10\Omega$ , $T_j = 125^\circ\text{C}$ (See Fig. 1, 2)	—	—	0.6	J/P
t <sub>s</sub>	Storage time	$I_T = 800\text{A}$ , $V_{DM} = 3/4 V_{DRM}$ , $V_D = 3000\text{V}$ $C_s = 0.1\mu\text{F}$ , $R_s = 10\Omega$ , $T_j = 125^\circ\text{C}$ (See Fig. 1, 5)	—	—	3	$\mu\text{s}$
E <sub>off</sub>	Turn-off switching energy	$I_T = 400\text{A}$ , $V_{DM} = 4000\text{V}$ , $V_D = 3000\text{V}$ $C_s = 0.1\mu\text{F}$ , $R_s = 10\Omega$ , $T_j = 125^\circ\text{C}$ (See Fig. 1, 5)	—	—	2.3	J/P
Q <sub>RR</sub>	Reverse recovery charge	$V_R = 3000\text{V}$ , $I_T = 400\text{A}$ , $di/dt = 1000\text{A}/\mu\text{s}$	—	—	1800	$\mu\text{C}$
E <sub>rec</sub>	Reverse recovery energy	$C_s = 0.1\mu\text{F}$ , $R_s = 10\Omega$ , $T_j = 125^\circ\text{C}$ (See Fig. 4, 5)	—	—	4.4	J/P
I <sub>GT</sub>	Gate trigger current	$V_D = 24\text{V}$ , $R_L = 0.1\Omega$ , $T_j = 25^\circ\text{C}$	—	—	0.5	A
V <sub>GT</sub>	Gate trigger voltage	DC method	—	—	1.5	V

**GCU08BA-130**

**HIGH POWER INVERTER USE  
PRESS PACK TYPE**

**GATE DRIVER PART**

Symbol	Parameter	Conditions	Limits			Unit
			Min	Typ	Max	
V <sub>GIN</sub>	Power supply voltage	DC power supply	19	20	21	V
P <sub>GIN</sub>	Gate power consumption	I <sub>T</sub> = 420Arms, f = 780Hz, duty = 0.33	—	—	35	W
t <sub>fd</sub>	Delay time of on gate current	T <sub>a</sub> = 25°C	—	—	3.0	μs
t <sub>rd</sub>	Delay time of off gate current	T <sub>a</sub> = 25°C	—	—	3.0	μs
—	Control signal	Optical fiber data link Transmitter : HFBR-1521 : Agilent Receiver : HFBR-2521 : Agilent	—	—	—	—
—	Power supply connector	Phoenix contact Type name : MSTB2.5/2-G-5.08AU	—	—	—	—
—	Status signal	— (Note 1)	—	—	—	—

**MECHANICAL DATA**

Symbol	Parameter	Conditions	Limits			Unit
			Min	Typ	Max	
F <sub>M</sub>	Mounting force	—	11.1	13	15.8	kN
—	Weight	—	—	1100	—	g
—	Pole piece diameter (GTC device)	±0.2mm	—	47	—	mm
—	Housing thickness (GTC device)	±0.5mm	—	26	—	mm

**THERMAL DATA**

Symbol	Parameter	Conditions	Limits			Unit
			Min	Typ	Max	
T <sub>j</sub>	Junction operating temperature	—	-10	—	125	°C
T <sub>stg</sub>	Storage temperature	—	-10	—	60	°C
T <sub>a</sub>	Ambient operation temperature	Recommend : ≤ 40°C	-10	—	60	°C
R <sub>t(j-f)</sub>	Thermal resistance	Junction to Fin	—	—	0.025	K/W

**GCU08BA-130**

**HIGH POWER INVERTER USE  
PRESS PACK TYPE**

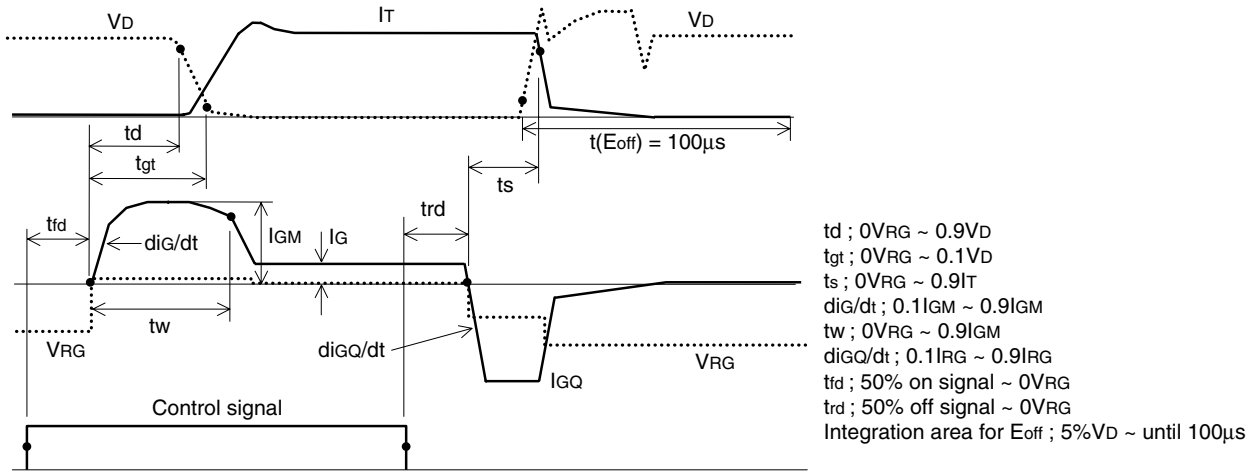

**Fig. 1 Turn-on and Turn-off waveform**

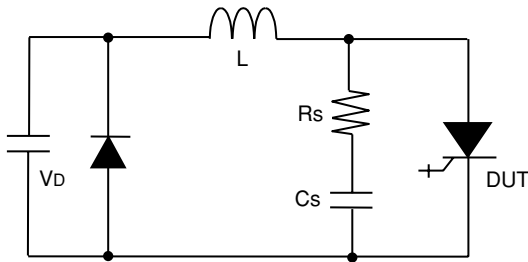

**Fig. 2 Turn-on test circuit**

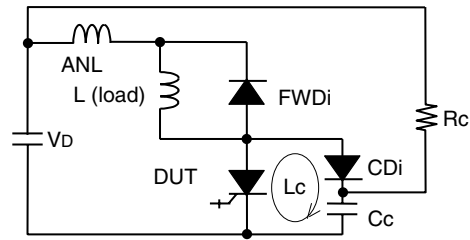

**Fig. 3 Turn-off test circuit  
(With clamp circuit)**

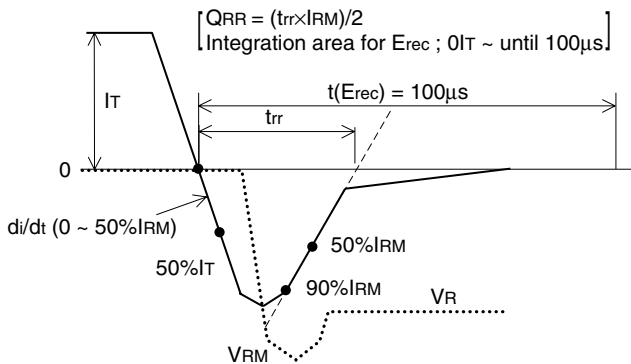

**Fig. 4 Reverse recovery waveform**

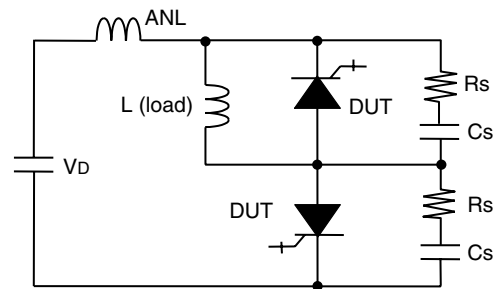

**Fig. 5 Turn-off and Reverse recovery test circuit**

# GCU08BA-130

HIGH POWER INVERTER USE  
PRESS PACK TYPE

Note 1. Status signal

## 1. Status signal from LED

### (1) Status signal

Status of GCT	LED 1 (Red)	LED 2 (Yellow)
On state	OFF	ON
Off state	ON	OFF

### (2) Fault signal

Status	G-K	Power Supply	G-K LED (LED 3) (Green)	PS LED (LED 4) (Green)
Normal	Normal	20±1V	On	On
Fault	Normal	Voltage down	Off	Off
Fault	G-K short	20±1V	Off	On
Fault	G-K short	Voltage down	Off	Off

## 2. Status signal from Transmitter

(L : Light NL : No light)

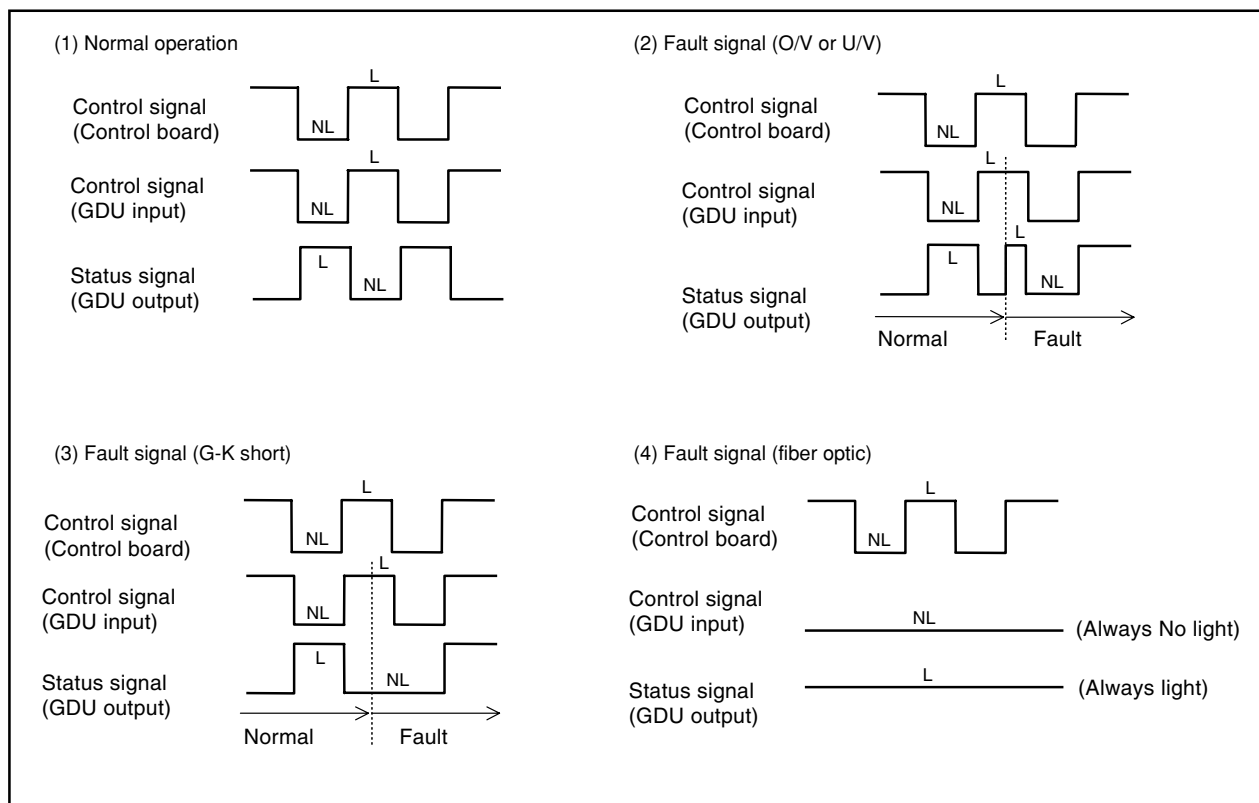

**GCU08BA-130**

**HIGH POWER INVERTER USE  
PRESS PACK TYPE**

**PERFORMANCE CURVES**

**MAXIMUM ON-STATE CHARACTERISTIC**

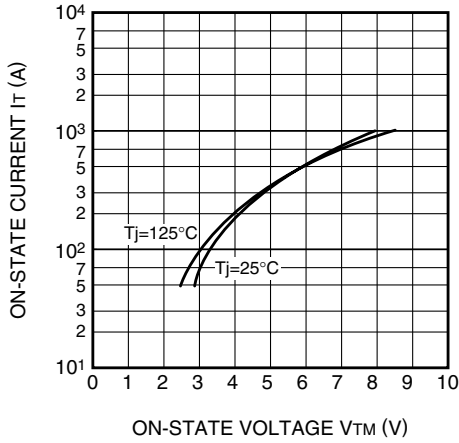

**$E_{on}$  VS  $I_T$  (Max)**

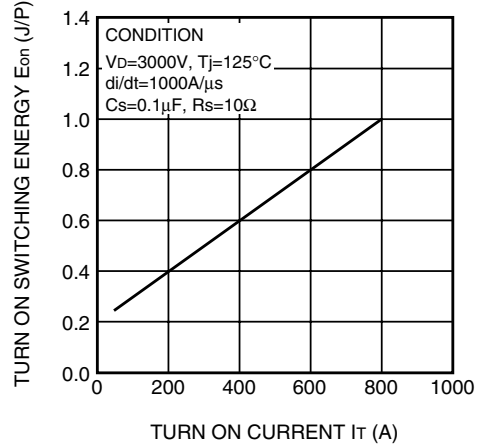

**$E_{off}$  VS  $I_T$  (Max)**

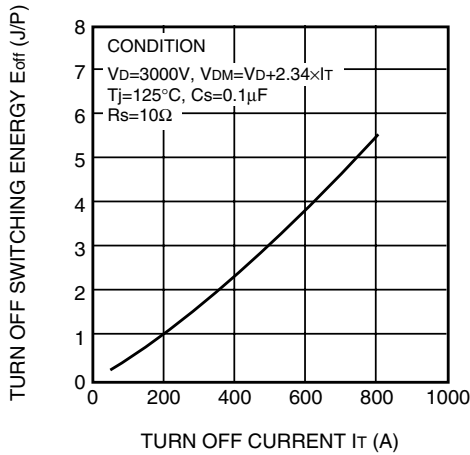

**$E_{rec}$  VS  $I_T$  (Max)**

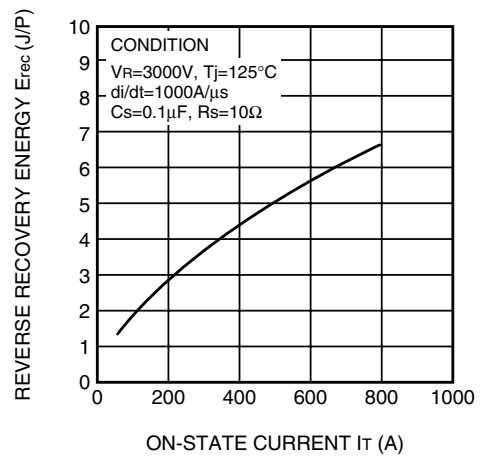

**MAXIMUM THERMAL IMPEDANCE CHARACTERISTIC (JUNCTION TO FIN)**

