

PACSystems* RX3i

IC695PSA040

GFK-2431E
August 2012

Power Supply, 120/240VAC or 125VDC, 40 Watts

The PACSystems[®] RX3i power supply IC695PSA040 is a 40-Watt supply that operates from an input voltage source in the range of 85 to 264 VAC or 100 VDC to 300 VDC.

This power supply provides three outputs:

- +5.1 VDC output.
- +24 VDC relay output that can be used to power circuits on Output Relay modules.
- +3.3 VDC. This output is used internally by RX3i modules with IC695 catalog numbers.

Caution

Only one IC695PSA040 can be installed in a PACSystems RX3i (IC695 catalog number) Universal Backplane. This Power supply cannot be used with other RX3i power supplies in redundant or increased capacity modes. Power Supply version IC695PSA040C and earlier may cause equipment damage if inadvertently installed in the same backplane as another RX3i power supply.

If the number of modules required exceeds the capacity of the Power Supply, the additional modules must be installed in Expansion or Remote backplanes or power supplies capable of increased capacity mode operation must be used.

The Power Supply indicates when an internal fault occurs so the CPU can detect loss of power or log the appropriate fault code.

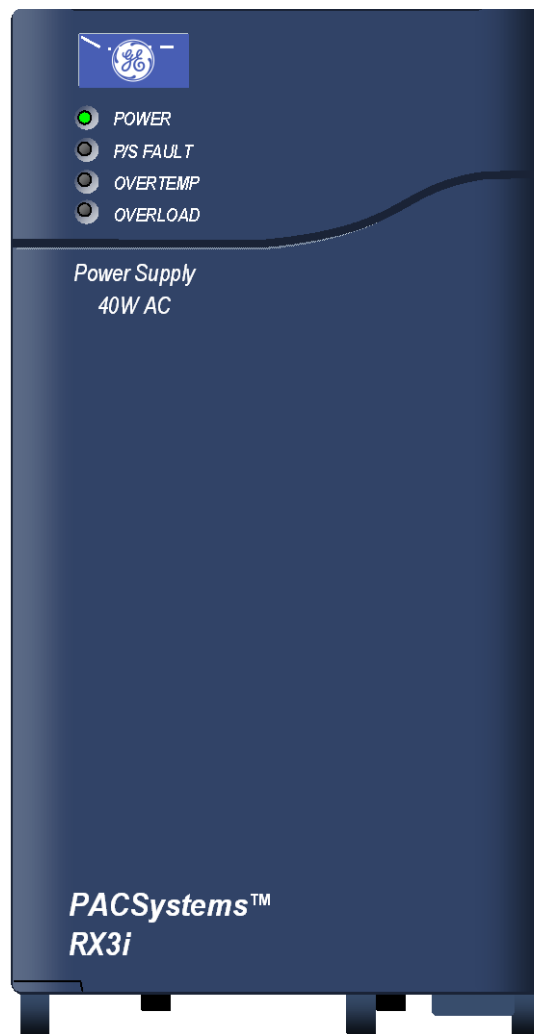

* indicates a trademark of GE Intelligent Platforms, Inc. and/or its affiliates. All other trademarks are the property of their respective owners.

GFK-2431E

Warning

The power supply's door must be closed. During normal operation with an AC power source either 120 VAC or 240 VAC is present on the AC Power Supply. The door protects against accidental shock hazard that could cause severe or fatal injury to personnel.

LEDs

Four LEDs on the Power Supply indicate:

- Power (Green/Amber). When this LED is green, it indicates power is being supplied to the backplane. When this LED is amber, power is applied to the Power Supply but the Power Supply switch is off.
- P/S Fault (Red). When this LED is lit, it indicates the Power Supply has failed and is no longer supplying sufficient voltage to the backplane.
- Over Temperature (Amber). When this LED is lit, it indicates the Power Supply is near or exceeding its maximum operating temperature.
- Overload (Amber). When this LED is lit, it indicates the Power Supply is near or exceeding its maximum output capability on at least one of its outputs.

The CPU Fault Table shows a fault if any Overtemperature, Overload, or P/S Fault occurs.

On/Off Switch

The ON/OFF switch is located behind the door on the front of the module. The switch controls the operation of the outputs of the supply. It does NOT interrupt line power. A projecting tab next to the switch helps prevent accidentally turning it on or off.

Wiring Terminals

Terminals for +24V and -24V power, ground, and MOV disconnect accept individual 14 to 22AWG wires.

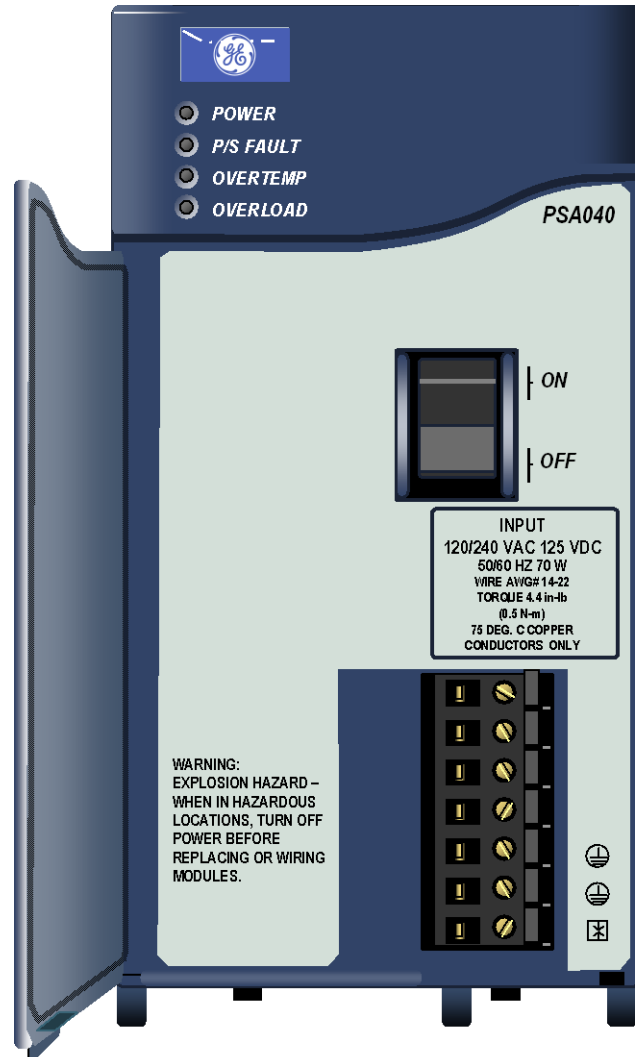

RX3i Power Supply, 120/240VAC or 125VDC, 40 Watts**3**

GFK-2431E

Specifications: IC695PSA040

Nominal Rated Voltage	120/240 VAC or 125 VDC
Input Voltage Range	
AC	85 to 264 VAC
DC	100 to 300 VDC
Input Power (Maximum with Full Load)	70 Watts maximum
Inrush Current	4 Amps, 250 milliseconds maximum *
Output Power	40 Watts maximum total 5.1 VDC = 30 Watts maximum 3.3 VDC = 30 Watts maximum The maximum total output power available depends on the surrounding air temperature, as shown.
Output Voltage	24 VDC: 19.2 VDC to 28.8 VDC 5.1 VDC: 5.0 VDC to 5.2 VDC (5.1 VDC nominal) 3.3 VDC: 3.1 VDC to 3.5 VDC (3.3 VDC nominal)
Output Current	24 VDC: 0 to 1.6 Amps 5.1 VDC: 0 to 6 Amps 3.3 VDC: 0 to 9 Amps
Isolation (input to backplane):	250 VAC continuous; 1500 VAC for 1 minute
Ripple (all outputs)	150 mV
Noise (all outputs)	150 mV
Ride-through time	20 ms. This is the length of time the Power Supply maintains valid outputs if the power source is interrupted
Wiring Terminals	Each terminal accepts one 14 AWG to 22 AWG wire.
Current per Terminal	6 Amps
Number of Daisy-Chain PSA040 Supplies	Up to 4

* The Inrush Current specification is given as a guide for sizing the external power source for the IC695PSA040. Peak inrush current may be higher for shorter durations.

For product standards, general operating specifications, and installation requirements, refer to the *PACSystems RX3i System Manual*, GFK-2314.

Installation Information for Hazardous Areas

The following information is for products bearing the UL marking for Hazardous Locations or ATEX marking for explosive atmospheres:

- WARNING - EXPLOSION HAZARD - SUBSTITUTION OF COMPONENTS MAY IMPAIR SUITABILITY FOR CLASS I, DIVISION 2;
- WARNING - EXPLOSION HAZARD - WHEN IN HAZARDOUS LOCATIONS, TURN OFF POWER BEFORE REPLACING OR WIRING MODULES; AND
- WARNING - EXPLOSION HAZARD - DO NOT CONNECT OR DISCONNECT EQUIPMENT UNLESS POWER HAS BEEN SWITCHED OFF OR THE AREA IS KNOWN TO BE NONHAZARDOUS.
- EQUIPMENT LABELED WITH REFERENCE TO CLASS I, GROUPS A, B, C & D, DIV. 2 HAZARDOUS LOCATIONS IS SUITABLE FOR USE IN CLASS I, DIVISION 2, GROUPS A, B, C, D OR NON-HAZARDOUS LOCATIONS ONLY

ATEX Marking

II 3 G Ex nA IIC T3C 0C_≤Ta_≥60C

GFK-2431E

Thermal Deratings

The maximum output power for Power Supply PSA040 depends on the surrounding air temperature, as shown below. Full output power is available up to at least 32°C (89.6°F).

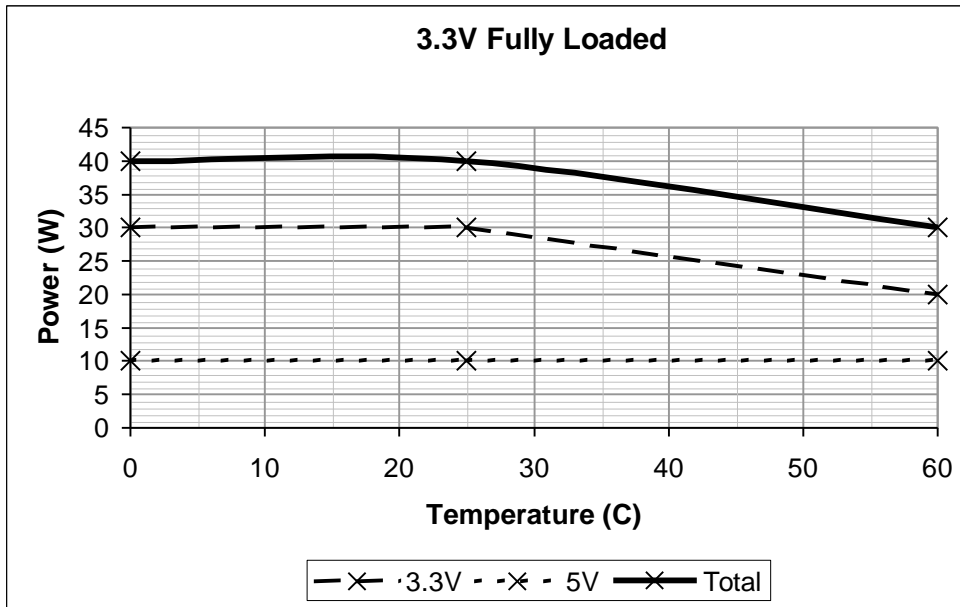
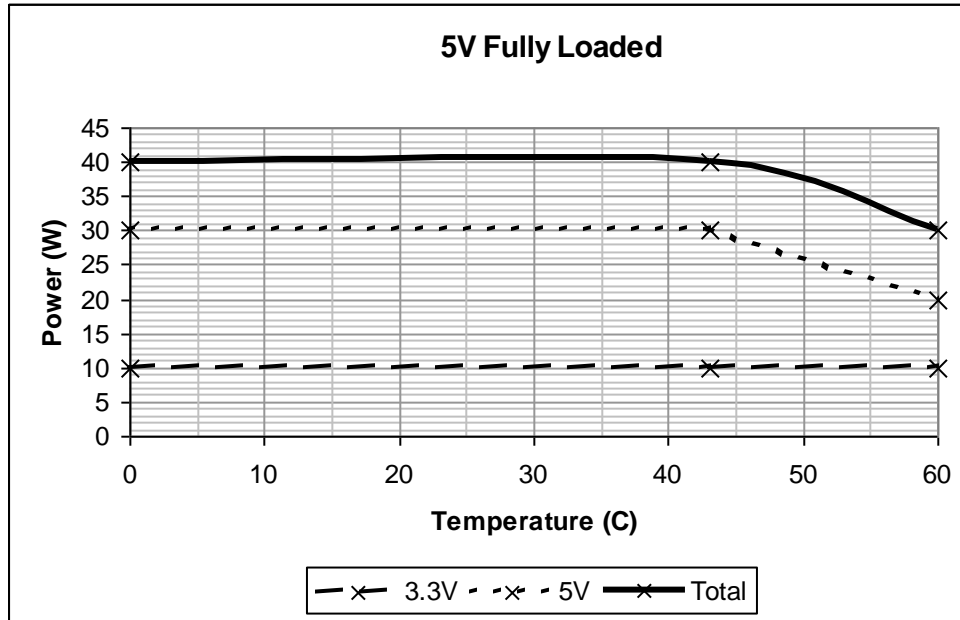

RX3i Power Supply, 120/240VAC or 125VDC, 40 Watts

Overcurrent Protection

The 5.1 VDC output is electronically limited to 7 Amps. The 3.3 VDC output is limited to 10 Amps. If an overload (including short circuits) occurs, it is sensed internally and the Power Supply shuts down. The Power Supply continually tries to restart until the overload condition is removed. A non-repairable internal fusible link in the input line is provided as a backup. The Power Supply usually shuts down before the fuse blows. The fuse also protects against internal supply faults. The CPU Fault Table shows a fault if any Overtemperature, Overload, or P/S Fault occurs. There is no additional indication if the Power Supply fuse blows.

Field Wiring: IC695PSA040

Power Source and Ground Connections

The wires from the power source and ground connect to the terminals on the Power Supply as shown at right.

Warning

If the same external DC power source is used to provide power to two or more power supplies in the system, connection polarity must be identical at each RX3i power supply. A resulting difference in potential can injure personnel or cause damage to equipment. Also, each backplane must be connected to a common system ground.

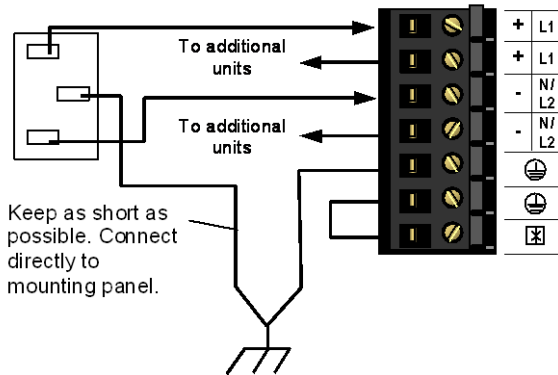

Input Overvoltage Protection

The bottom terminal is normally connected to frame ground with a user-installed jumper as shown at lower right. If overvoltage protection is not required or is supplied upstream, no jumper is required.

To Hi-pot test this supply, overvoltage protection must be disabled during the test by removing the jumper. Re-enable overvoltage protection after testing by reinstalling the jumper.

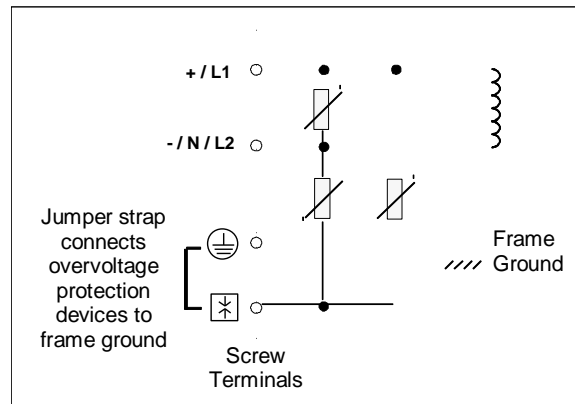

Power Supply Field Wiring Terminals

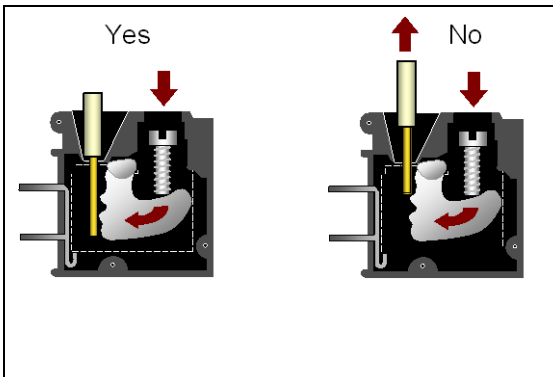

Each terminal accepts one AWG 14 to AWG 22 wire. The end of each wire should be stripped at least 3/8-inch (9mm). The terminal can accept a wire that is stripped up to 11 mm (.433 in) while providing full seating of the insulator. The wire must be fully inserted as shown at left, so that the insulation meets the insulation stop position inside the terminal. Tightening the terminal screw pivots the clamp firmly against the stripped end of the wire, holding it in place. If the wire is not fully inserted as shown at right, tightening the terminal screw may push the wire upward so that it is not connected.

When tightening the screw terminals, do not exceed the maximum torque limit of 0.5 N-m (4.4 inch-lbs).

GFK-2431E

Important Product Information

Revision History

<i>Version</i>	<i>Date</i>	<i>Details</i>
IC695PSA040H	Aug. 2012	Resolves an issue with powering up under light loads.
IC695PSA040G	Jun. 2011	Hardware modification improves radiated RF susceptibility and removes the requirement to install control systems that use this product in a grounded metal enclosure to meet the EU EMC Directive.
IC695PSA040F	Sep. 2006	Hardware modification. Previous versions of this Power Supply occasionally failed to power up when installed in a 16-Slot Universal Backplane, IC695CHS016. This update resolves the issue.
IC695PSA040E	Mar. 2006	The D version of this Power Supply (IC695PSA040D) incorrectly reported that it was a PSA140 power supply, causing a Configuration Mismatch error. The E version and versions prior to D report their identification correctly.
IC695PSA040A	Oct. 2005	Initial release

Problems Resolved by this Revision

IC695PSA040 may fail to power up under light loads

Earlier versions of the power supply may fail to turn on when newer modules (such as the CPE305, PNC001, and derivatives) are installed in the backplane. This problem is corrected in the H version.

CONTACT US & SUPPORT

NEED A QUOTE OR TECHNICAL PARTS REPLACEMENT?

Company: [PLC ProTech Ltd.](#)
Website: www.plcprotech.com
Email: sales@plcprotech.com
Phone: +86 180 4631 7198

Our Service Guarantee:

- 100% Brand New Original & Factory Sealed Components
- 12-Month Quality Warranty on All Industrial Parts
- Worldwide Same-Day Fast Dispatch via DHL / FedEx

[SUBMIT ONLINE RFQ \(REQUEST FOR QUOTE\) >>](#)

[About Us](#) · [Contact](#) · [All Products](#)